

# SUPERPLAN PLUS

- elegant, puristic design
- can be installed to be absolutely flush with the floor
- maximum standing comfort thanks to the flat enamelled waste cover that is set flush in the shower tray
- made of KALDEWEI steel enamel



Similar illustration

Model 481	KA 120 horizontal	KA 120 flat	KA 120 vertical
Total height	108	88	49
Fitting height	83	63	83

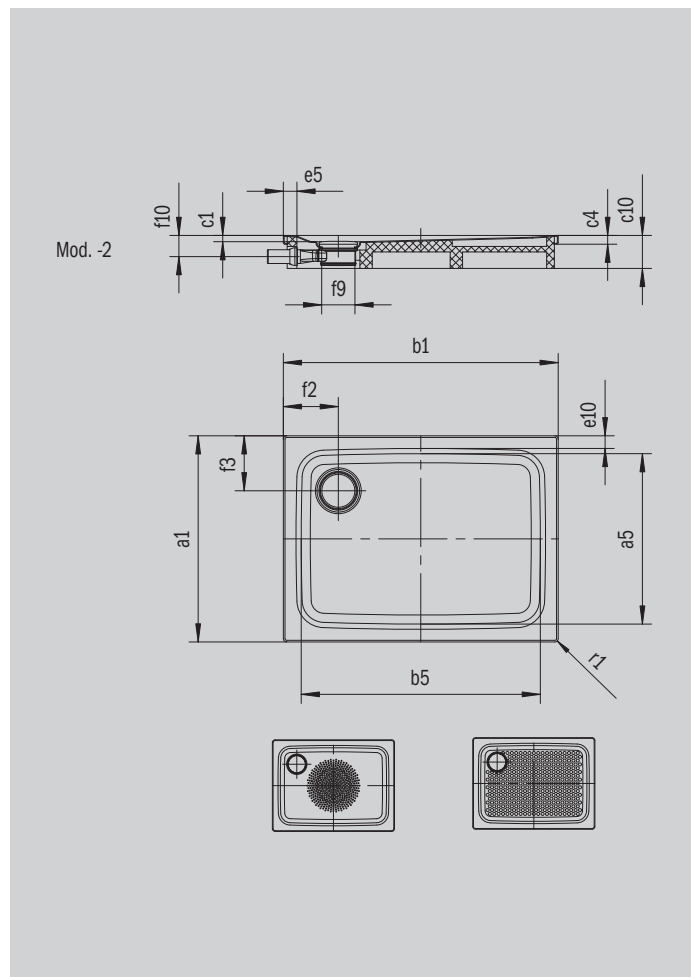

ANTISLIP  
**SECURE<sup>+</sup>**

Model		481
External length	$a_1$	700 mm
Internal length	$a_5$	590 mm
External width	$b_1$	1200 mm
Internal width	$b_5$	1090 mm
Depth inside	$c_1$	25 mm
Height of rim	$c_4$	32 mm
Height with support	$c_{10}$	120 mm
Total height (height with bottle trap)	$c_{17}$	109 mm
Width of rim	$e_{10}, a_5$	50; 50 mm
Diameter of waste hole	$f_9$	Ø 120 mm
Bottle trap connection height	$f_{10}$	78 mm
Distance bath edge to centre of waste hole	$f_{21}, f_3$	200; 200 mm
External radius	$r_1$	12 mm
Net weight		23 kg
Diameter of anti-slip		Ø 435 mm
Full anti-slip		462 x 997 mm
ANTI-SLIP SECURE PLUS		full base

**KALDEWEI**