

SCONA

- harmonious design with centrally-placed waste
- can be installed absolutely flush to floor
- made of KALDEWEI steel enamel
- flush-fitting recessed waste cover (only in combination with the KA 90 waste fittings)

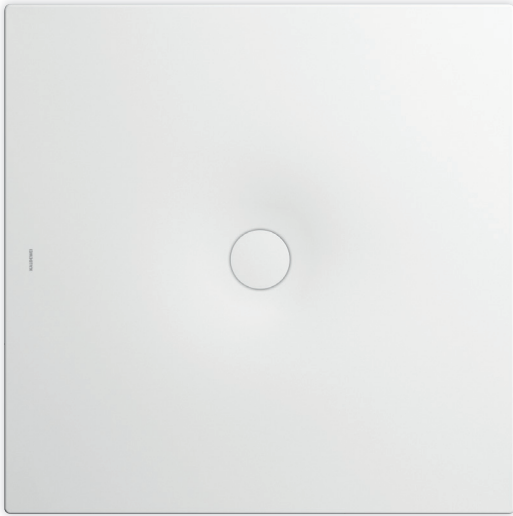

Similar illustration

Model 976	KA 90 horizontal	KA 90 flat	KA 90 vertical
Total height	103	83	37
Fitting height	80	60	80

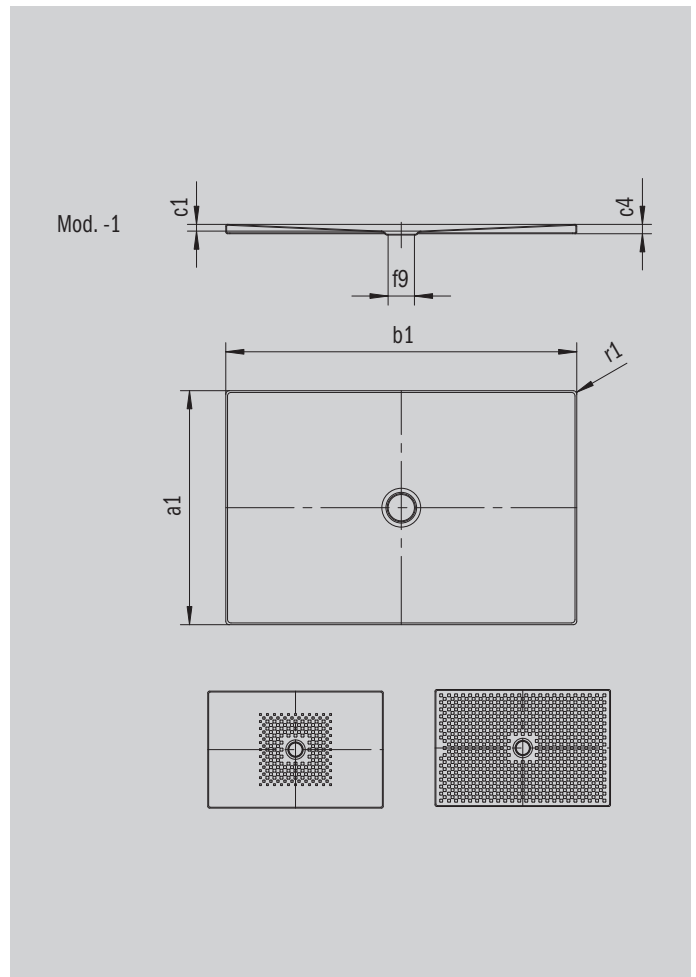

ANTISLIP
SECURE⁺

Model		976
External length	a_1	800 mm
External width	b_1	1400 mm
Depth inside	c_1	23 mm
Height of rim	c_4	32 mm
Height with low-profile support	c_{16}	37 mm
Diameter of waste hole	f_9	Ø 90 mm
External radius	r_1	12 mm
Net weight		29 kg
Anti-slip		492 x 492 mm
Full anti-slip		740 x 1316 mm
ANTI-SLIP SECURE PLUS		full base

KALDEWEI