

SCONA

- harmonious design with centrally-placed waste
- can be installed absolutely flush to floor
- made of KALDEWEI steel enamel
- flush-fitting recessed waste cover (only in combination with the KA 90 waste fittings)



Similar illustration

Model 964	KA 90 horizontal	KA 90 flat	KA 90 vertical
Total height	103	83	37
Fitting height	80	60	80

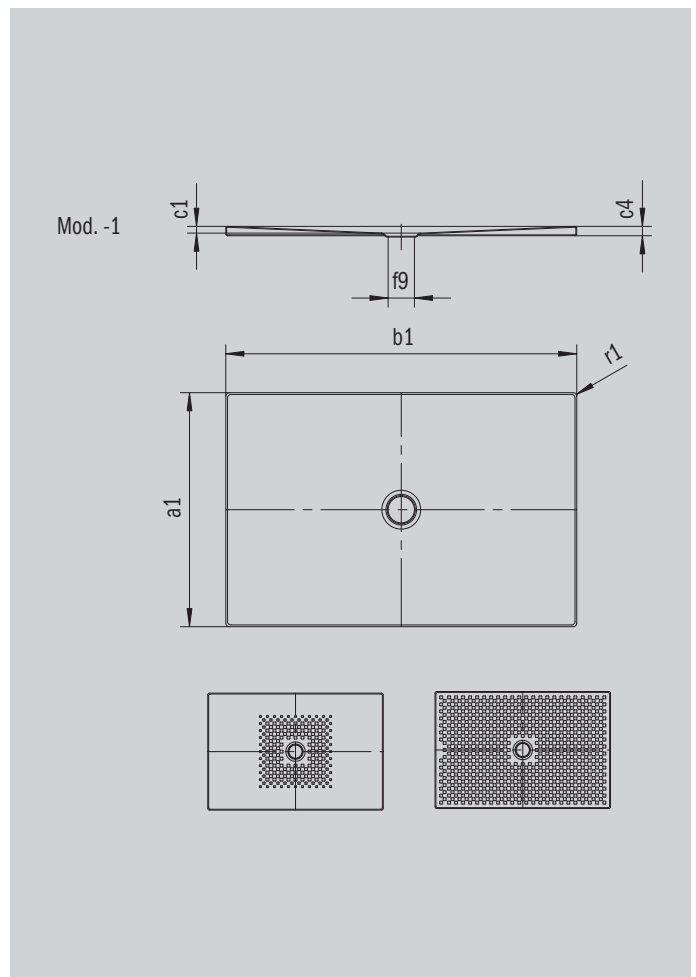

ANTISLIP
SECURE⁺

Model		964
External length	a_1	1000 mm
External width	b_1	1100 mm
Depth inside	c_1	23 mm
Height of rim	c_4	32 mm
Height with low-profile support	c_{16}	37 mm
Diameter of waste hole	f_9	Ø 90 mm
External radius	r_1	12 mm
Net weight		27 kg
Anti-slip		492 x 492 mm
Full anti-slip		932 x 1028 mm
ANTI-SLIP SECURE PLUS		full base

KALDEWEI