

SUPERPLAN

- exclusive, elegant design
- made of KALDEWEI steel enamel
- flush-fitting recessed waste cover (only in combination with the KA 90 waste fittings)



Similar illustration

Model 436	KA 90 horizontal	KA 90 flat	KA 90 vertical
Total height	120	100	49
Fitting height	80	60	80

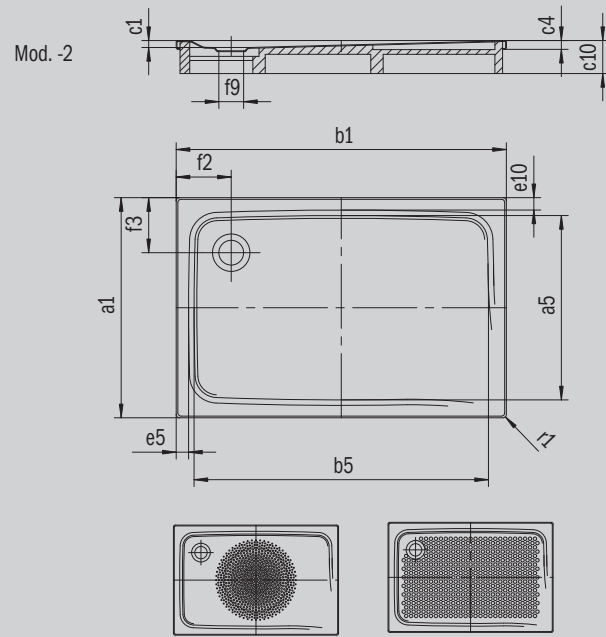

ANTISLIP
SECURE⁺

Model		436
External length	a_1	750 mm
Internal length	a_5	650 mm
External width	b_1	1600 mm
Internal width	b_5	1280 mm
Depth inside	c_1	40 mm
Height of rim	c_4	32 mm
Height with support	c_{10}	135 mm
Width of rim	$e_{10}; e_5$	50; 150 mm
Diameter of waste hole	f_9	Ø 90 mm
Distance bath edge to centre of waste hole	$f_{21}; f_3$	300; 200 mm
External radius	r_1	12 mm
Net weight		32 kg
Anti-slip		300 x 856 mm
Full anti-slip		524 x 1177 mm
ANTI-SLIP SECURE PLUS		full base

KALDEWEI