

# SUPERPLAN

- exclusive, elegant design
- made of KALDEWEI steel enamel
- flush-fitting recessed waste cover (only in combination with the KA 90 waste fittings)



Similar illustration

Model 401	KA 90 horizontal	KA 90 flat	KA 90 vertical
Total height	105	85	37
Fitting height	80	60	80

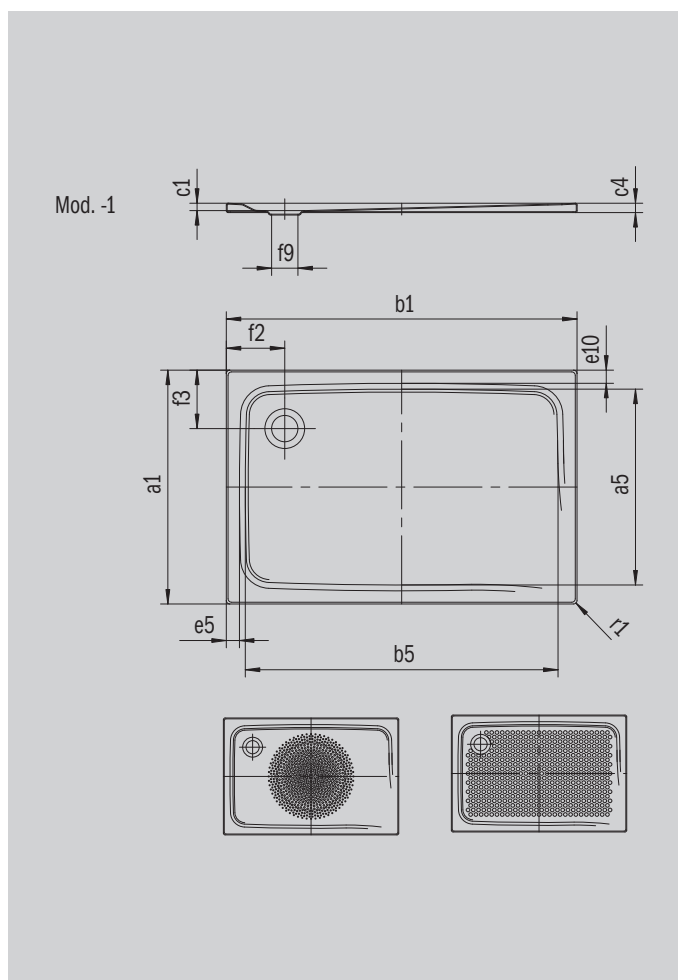

ANTISLIP  
**SECURE<sup>+</sup>**

Model		401
External length	$a_1$	700 mm
Internal length	$a_5$	590 mm
External width	$b_1$	1200 mm
Internal width	$b_5$	1090 mm
Depth inside	$c_1$	25 mm
Height of rim	$c_4$	32 mm
Height with low-profile support	$c_{16}$	37 mm
Width of rim	$e_{10}, e_5$	50; 50 mm
Diameter of waste hole	$f_9$	Ø 90 mm
Distance bath edge to centre of waste hole	$f_{21}, f_3$	200; 200 mm
External radius	$r_1$	12 mm
Net weight		23 kg
Diameter of anti-slip		Ø 435 mm
Full anti-slip		461 x 997 mm
ANTI-SLIP SECURE PLUS		full base

**KALDEWEI**